



QB1-21XE

Installation Manual and Product Registration Guide

Important

Failure to install the Showersave QB1-21XE as specified may adversely affect the performance of the shower and impact on the Energy Performance Certificate at the end of construction.

Failure to correctly register this installation with the Showersave App (see page 7) may invalidate product warranty.



Scan QR code to view Showersave
Unboxing and Installation videos

QB1-21XE Waste Water Heat Recovery (WWHR)

The Showersave QB1-21XE included in the design SAP calculation is the highest performing WWHR unit in its category. Substitution with a “generic” alternative from another manufacturer will impact on the Energy Performance Certificate at the end of construction.

Each Showersave QB1-21XE is labelled as follows:

NCM (SAP) Identifier	Showersave QB1-21XE		Building Products Distributors Ltd Unit 21 Avondale Business Park, Ballyclare, Co. Antrim, BT39 9AU
Technology type	Waste Water Heat Recovery System (WWHRS)		
Technology category	Instantaneous Shower Heat Recovery		
Manufacturer	BPD Ltd	Brand Name	Showersave
Serial no.	2-21BD00002		
Model name	QB1-21XE		
Model qualifier	System A / System B / System C		(delete as appropriate)
<p>This dwelling is fitted with a Waste Water Heat Recovery System (WWHRS) which is recognised by the Governments Standard Assessment Procedure (SAP) for Energy Rating of Dwellings. Note: One label should be permanently affixed to the WWHRS unit and another to a nearby Boiler or Service cupboard.</p>			

Part Number	Description
QB1-21XE	Showersave, 50mm Heat Exchanger, Copper
Cyclone	Showersave, 50mm Cyclone
Z28L-ISO	McAlpine, 2"/50mm Bottom Connector, PP/PVCU
33435061 6263808	Walraven, Pipe Clamps, 2S Clamp zinc plated EPDM M8/10 53-61mm Walraven, Hanger Bolts, zinc plated TorxM8*80mm

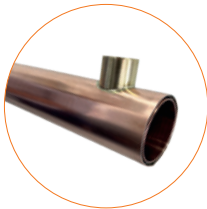

QB1-21XE



Cyclone



Z28L-ISO



**33435061
6263808**

There are three installation methods shown below, each having an effect on the WWHRS performance and efficiency. The Showersave should be installed by a suitably qualified plumber, and installed in the method as specified in SAP.

The performance of all 3 systems are recognised within the SAP Products Characteristics Database (PCDB) where the relevant efficiencies can be found www.ncm-pcdb.org.uk/sap

System A - SAP Code 080201

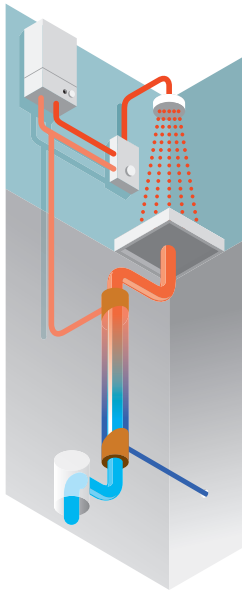

Pre warmed water feeds the cold inlet of both the shower and hot water heater.

System B - SAP Code 080203

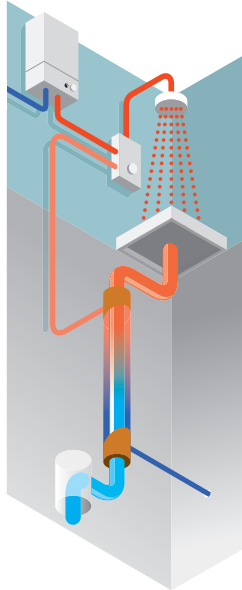

Pre warmed water feeds the cold inlet of the shower only.

System C - SAP Code 080205

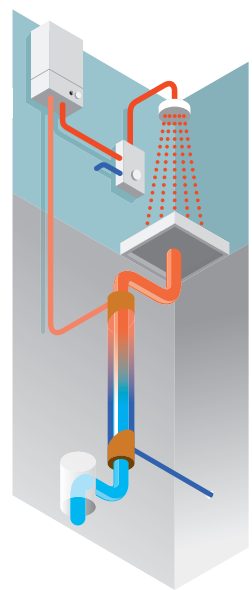

Pre warmed water feeds the cold inlet of the water heater only.

Please Note - All schematics are drawn showing a Combi Boiler as the hot water source. The same installation principle also applies if the hot water is supplied using a System Boiler, Unvented Cylinder, Heat Pump or Electric Boiler.

Installation guidance

- 1 Install the Showersave QB1-21XE vertically to a solid surface, using the 2 brackets and hanger bolts supplied.
- 2 Connect the waste water to the Cyclone and the Cyclone to the top of the pipe. Use suitable lubricant on the O-rings.



- 3 Using the straight through McAlpine Z28L-ISO compression connector supplied, connect the waste from the bottom of the Showersave QB1-21XE to the SVP.



- 4 The mains water supply is connected to the bottom of the QB1-21XE using 1/2" BSP male 15/22mm fitting.



- 5 Only use PTFE liquid/tape to seal the thread, **DO NOT USE HEMP** and **DO NOT OVER TIGHTEN**.
- 6 Install an isolator to both inlet and outlet mains water supply. These can be installed anywhere in the property.
- 7 Connect the 1/2" BSP male 15/22mm fitting to the outlet of the QB1-21XE and connect in system A,B or C.
- 8 Do not wrap the Showersave QB1-21XE with insulation.
- 9 **You can pressure test up to 20 bar.**

Important - Mark the 2nd SAP Identifier label supplied as required and apply to the boiler cabinet so it is easily visible to an energy assessor, should the homeowner commission a Home Buyers EPC report. **Failure to do** this will invalidate the installation.



The QB1-21XE installation must be registered via the Showersave App.



Scan QR code to view Installation videos

Legionella risk and mitigation: When no cold water is flowing up the Showersave, the temperature in the pipe should be prevented from becoming higher than 25°C.

It must not be installed near heat conducting pipes, on warm surfaces or in spaces with constantly high temperatures (>25°C).

The cold water pipe, connection and the outer wall of the Showersave should not be insulated.

Installing the Showersave in system A or C will mean that whenever the hot water system runs the cold water system will be flushed. This will minimise stagnation and complies with recommendations within ACOP L8.

Where it is not possible to ensure a Tee at the cold side of the shower's thermostatic mixing valve, then a "venturi" effect assembly should be considered. This is a straightforward assembly of different pipe diameters to ensure stagnation on the cold side is minimised.

Fig.1 System A Schematic - Specification

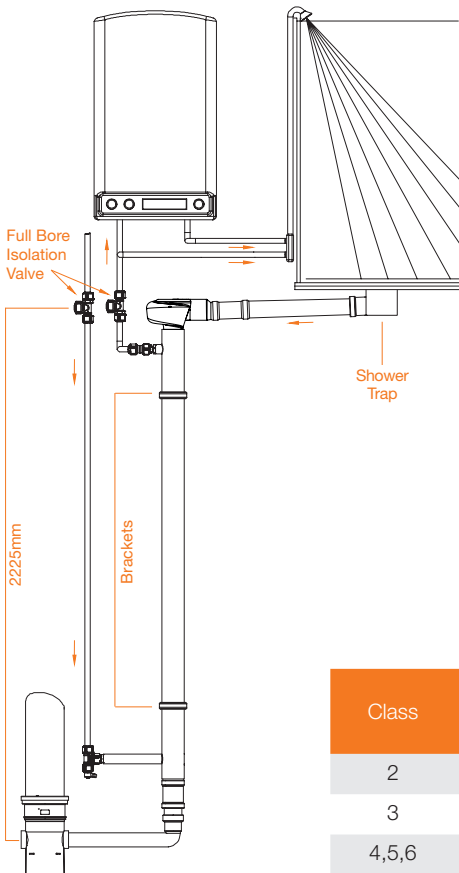
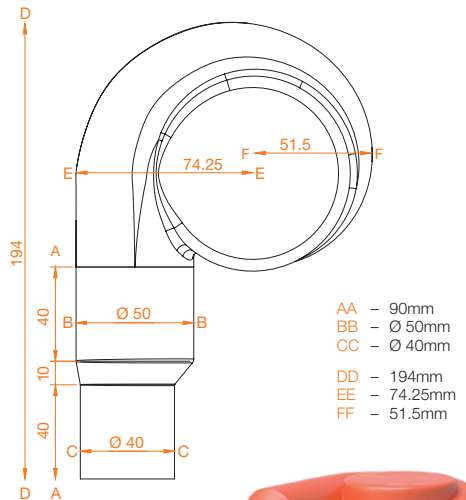

Fig.2 Cyclone - Specification



Class	Flow (l/min)	Volume (l)	Efficiency (%)	Flow resistance (ΔP) (bar)
2	5.8	47	70.5	0.14
3	9.2	73	66.3	0.31
4,5,6	12.5	100	62.8	0.53

Boxing off detail

- 1 The QB1-21XE Cyclone can be located in the ceiling void, if required.
- 2 The size of the boxed off unit will be no more than 2,400mm in height, 340mm in width and 240mm in depth.
- 3 The boxing off needs to be in accordance with the NHBC standards AD part E.
- 4 The Showersave QB1-21XE is considered a device. The space it is installed in should be large enough so that inspection can be carried out. Access should be possible without too much work.
- 5 The cold inlet/outlet can come from any location.

Warranty

The Showersave QB1-21XE comes with a 5 year warranty. The warranty is conditional on the system being installed in accordance with this manual and registered. It must also meet all the requirements of this manual if the system is to be recognised within SAP Assessments and therefore Part L of the Building Regulations (Part F Northern Ireland).

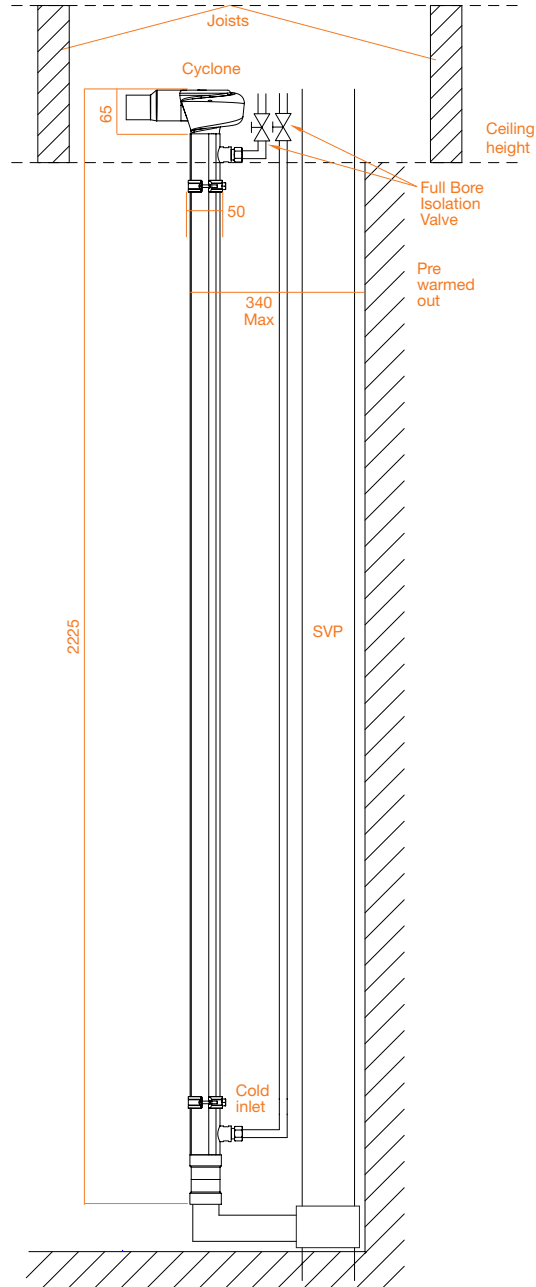

Registration guidance

Registering an installation using the Showersave App should take less than one minute.

If an installer is unable to access the App on-site, please contact us on **028 9334 4488** or email **sales@showersave.com** to discuss alternative methods of registration.

Install & Open App

Create user account by selecting **“Register”** and completing user details. Enter email address and select **“Login”**

Scan **“QR Code”** on the Showersave pipe.

Complete fields as requested:

- **Unit Model:** Select relevant model from dropdown menu.
- **Serial number:** Available from label affixed to Showersave unit.
- **Date & time:** Automatically populated.
- **Name of development:**
Enter development name.
- **Name of developer:** Select from dropdown menu, if not listed contact Showersave.
- **Plot / House number:** Enter relevant house / Plot number. (Street name and postcode can also be entered, if known).
- **Name of main installation Company:**
Enter name of Installation company.
- **Latitude/ Longitude:** Select pointer icon, which will automatically populate latitude/ longitude fields. Once this information is complete, select **“Done.”**

Uploading photographs

Select **“Take photographs and follow on-screen guidance to ensure that correct photos are taken.**

Note: One photograph should clearly show the label attached to Showersave unit, including serial number, Model name and Model Qualifier. Installer should indicate on the product label, if System A, B or C has been used.

The second photograph must show the full length Showersave installation in situ.

Two photographs must be uploaded.

Select **“Back to unit details.”**

Select **“Register Unit”** to Complete registration.

User will receive on-screen notification **“Unit successfully registered.”**



 **App Store**

Scan for Apple Store



 **Google Play**

Scan for Google Store

Confirmation of Registration - Select **“Registered Installations”** from the main menu.
- A list of all registered installations will be displayed

Important

It is now a Legal requirement under new Building Regulations to register Showersave installations.

This is not a request from Showersave.

Registering an installation is simple and will ensure product warranty is validated.



Contact Us

Building Products Distributors Ltd

Unit 21 Avondale Business Park, Ballyclare,
Co Antrim, BT39 9AU

T +44(0)28 9334 4488

E sales@showersave.com

www.showersave.com



Scan for Apple Store



Scan for Google Store